



Atlas Copco



# Complete submersible dewatering solutions

The WEDA range (50 Hz)

# WEDA dewatering pumps

WEDA electric submersible pumps and accessories are designed for an extensive range of dewatering applications, across multiple industries. They provide the performance, reliability and ease of use you need. WEDA pumps feature a built-in starter and motor protection system along with optional automatic level control. Adjustable wear-resistant rubber diffusers and hardened high-chrome impellers ensure durability in tough environments.

At Atlas Copco, we understand pumps, their applications and, most importantly, the people using them. We have a complete range of high-quality and lightweight electric submersible pumps designed specifically for drainage, sludge and slurry pumping applications and available in global voltages.















WEDA pumps are made for durability. The unique sealing system and modular design make them among the most flexible pumps on the market. Easy to use and maintain, WEDA pumps promise optimal performance. The WEDA seal system is designed to provide the optimum maintenance solution and can be easily fitted at the job site.



# There is a WEDA pump for any dewatering application

We understand the dewatering needs of our customers, which vary with location and application. Accordingly our submersible range is developed for drainage (D), sludge (S) and slurry (L) applications.

These applications call for pumps designed specifically for handling corrosive and abrasive media and their solid contents.

Drainage pumps (WEDA D)	Sludge pumps (WEDA S)	Slurry pumps (WEDA L)
		
 <p>WATER DENSITY UP TO <b>1100</b> kg/m<sup>3</sup></p>	 <p>WATER DENSITY UP TO <b>1400</b> kg/m<sup>3</sup></p>	 <p>WATER DENSITY UP TO <b>1700</b> kg/m<sup>3</sup></p>
 <p>DESIGN <b>TOP</b> DISCHARGE</p>	 <p>DESIGN <b>BOTTOM SIDE</b> DISCHARGE</p>	 <p>DESIGN <b>BOTTOM SIDE AND</b> <b>TOP DISCHARGE</b></p>
 <p><b>SOLIDS</b> HANDLING <b>4-12</b> mm</p>	 <p><b>SOLIDS</b> HANDLING <b>25-50</b> mm</p>	 <p><b>SOLIDS</b> HANDLING <b>20-60</b> mm</p>
 <p><b>pH VALUES</b> FROM <b>5 TO 8</b></p>	 <p><b>pH VALUES</b> FROM <b>5 TO 8</b></p>	 <p><b>pH VALUES</b> FROM <b>2 TO 10</b></p>

## Applications

- General dewatering
- Ground water
- Raw water
- Construction sites
- Water containing mud
- Sludge or light slurry
- Tank clean-out
- Trench and pond cleaning
- Mining
- Abrasive media with high solids content
- Quarries
- Dredging
- Settling ponds

# WEDA D range

The WEDA drainage pumps handle either clean or dirty water, even with small solids with the best performance and efficiency.

## HIGH CORROSION RESISTANCE

Unique aluminum alloy offers the perfect combination of strength, light weight and corrosion resistance

## FLEXIBILITY

Discharges can be mounted vertically or sideways as required

## MOTOR PROTECTION

Class F motors, with thermal switches in each winding

## EXTENDED PERFORMANCE

Pump design ensures all-round motor cooling for better performance

## WEDA+

1. Rotation control
2. Phase failure protection
3. Thermal switches
4. Phase shifter plugs for three-phase pumps

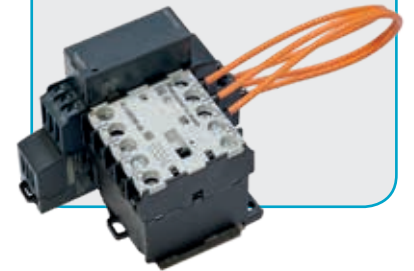

## IMPROVED CABLE SEALING

Ensures protection against water leakage from cable entry

## MODULAR SEALING SOLUTION

Based on pump size, the sealing system is adapted to provide the best solution

## IMPROVED WEAR RESISTANCE

High-chrome (55HRC) impellers provide higher wear resistance

55 HRC 

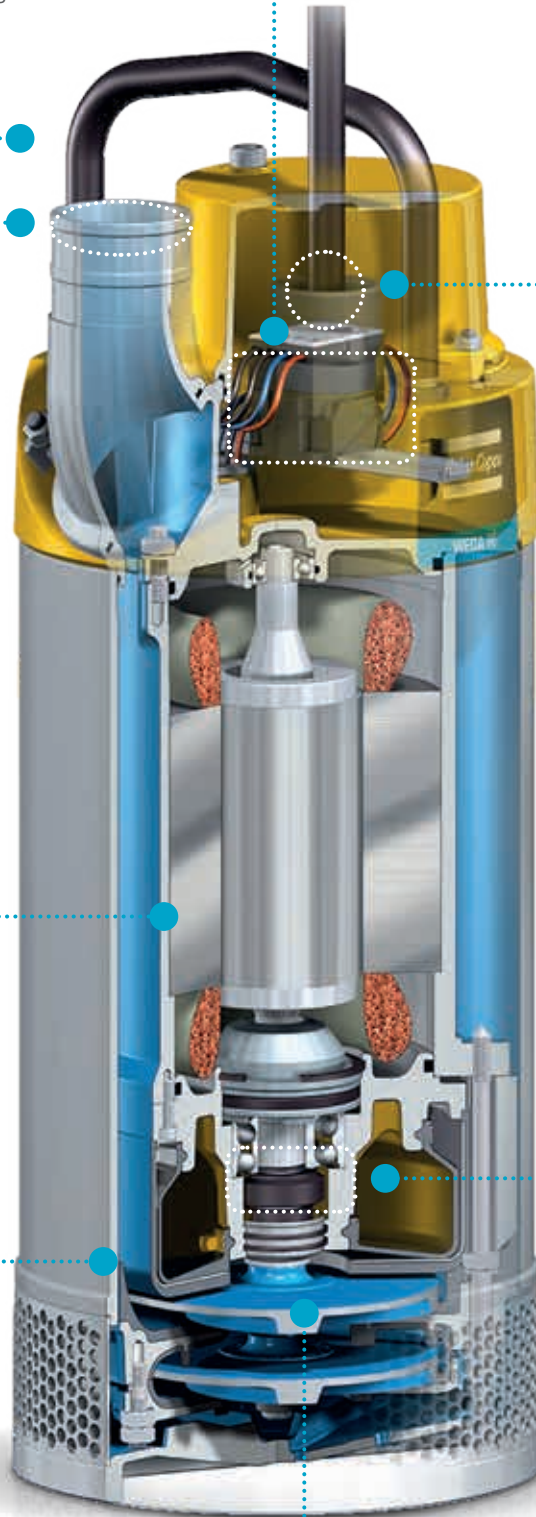

# WEDA S range

The WEDA sludge pumps can handle thick, soft, wet mud or other similarly viscous mixtures of liquids and solids, especially the product of an industrial or refining process.

## IMPROVED CABLE SEALING

Ensures protection against water leakage from cable entry

## DRY RUNNING CAPABILITIES

Improved rib design offers external cooling to motor for extended running time

## MOTOR PROTECTION

Class F motors, with thermal switches in each winding

## HIGHER SOLIDS HANDLING

Sludge pumps can handle solids up to 50 mm

 **SOLIDS HANDLING**  
**25–50<sub>mm</sub>**

## ROBUST DESIGN

Base of the pump ensures stability while enabling passage of large solids

## WEDA+

1. Rotation control
2. Phase failure protection
3. Thermal switches
4. Phase shifter plugs for three-phase pumps

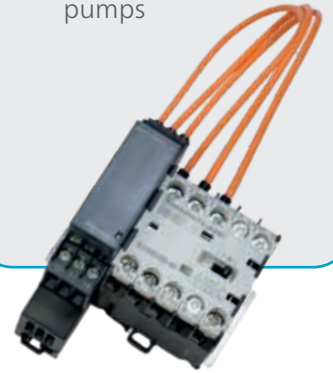

## EASY INSPECTION

External oil inspection plug for quick inspection of oil

## MODULAR SEALING SOLUTION

Based on pump size, the sealing system is adapted to provide the best solution

## SUSTAINABLE PERFORMANCE

High-chrome (55HRC) impellers provide higher wear resistance

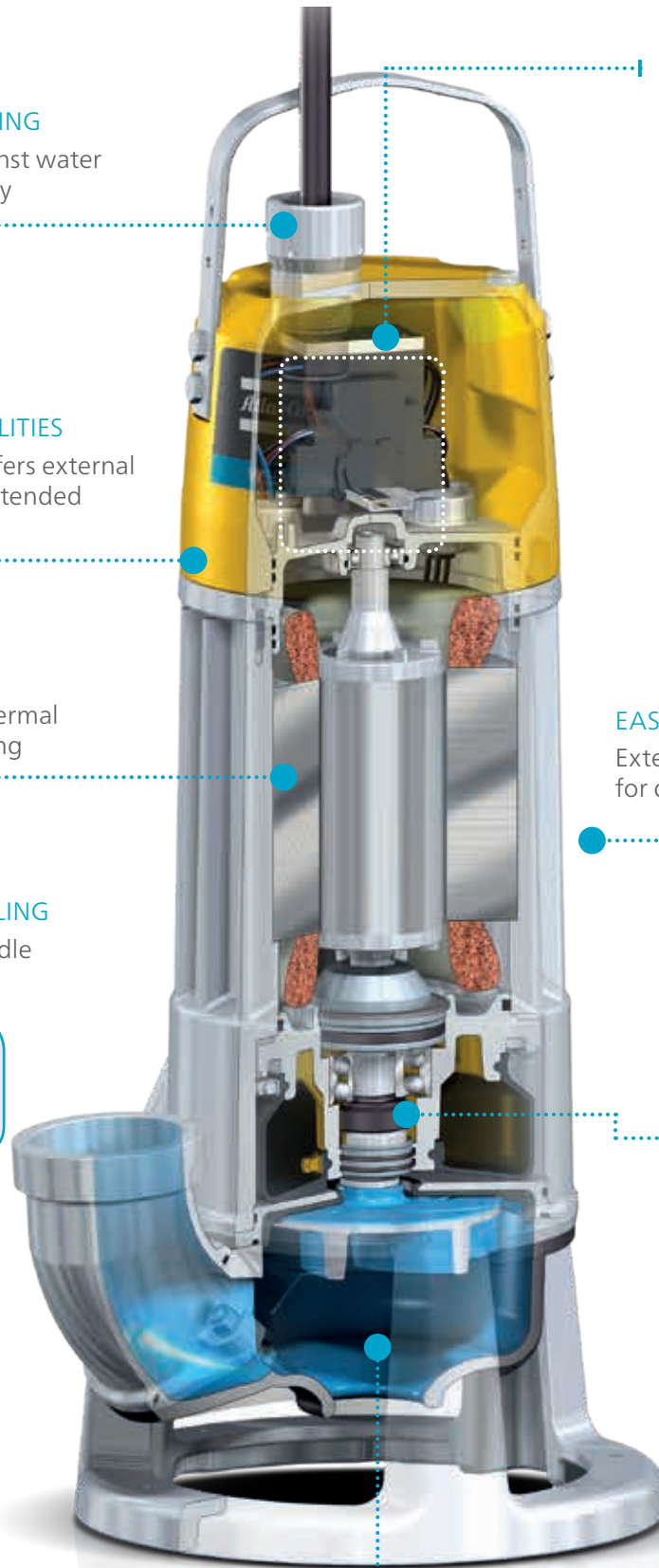

# WEDA L range

The WEDA slurry pumps are the toughest, and have the largest apertures to facilitate handling of slurry with the most challenging solids.

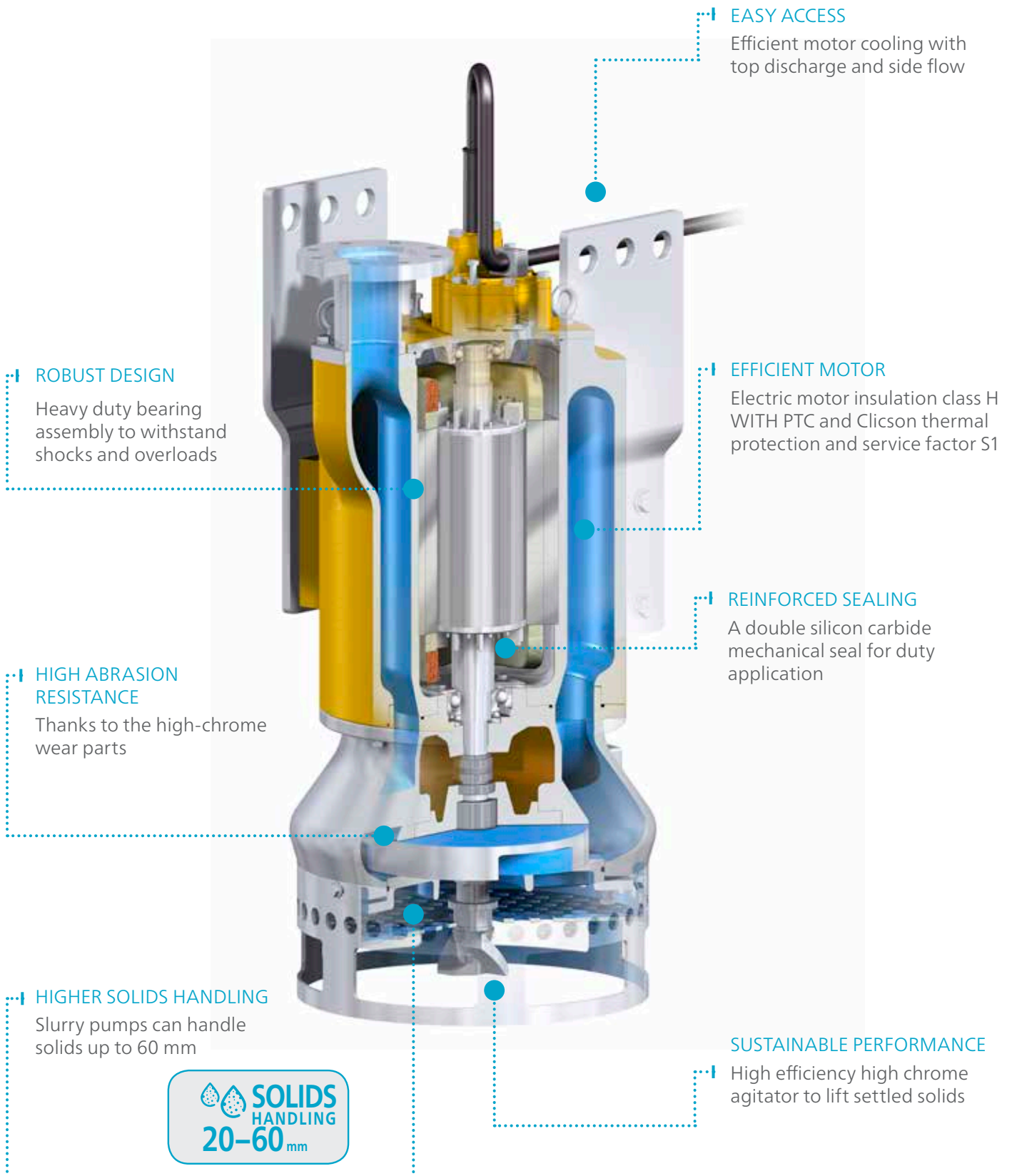



# WEDA D range

## Technical data



		WEDA D04N	WEDA D04BN	WEDA D08N	WEDA D10N		WEDA D30L		WEDA D30N		WEDA D40N
Specifications		1ph	1ph	1ph	1ph	3ph	1ph	3ph	1ph	3ph	3ph
Max. head	m	11,3	12,0	15,2	15,0	15,0	16,5	16,5	23	23	21
Max. flow	l/min	250	224	325	470	480	1250	1250	850	850	1320
	m <sup>3</sup> /h	15,0	13,5	19,5	28	29	75	75	51	51	79
Rated output	kW	0,40	0,40	0,8	1,0	1,0	2,0	2,0	2,0	2,0	3,0
Max. power input	kW	0,65	0,65	1,2	1,2	1,2	2,6	2,5	2,6	2,5	3,4
Discharge connection	in	2"	1" (2" optional)	2"	2"	2"	3" (4")	3" (4")	3" (4")	3" (4")	3" (4")
Max solids handling size	mm	7,5	4,5	7,5	4	4	7	7	7	7	7
Weight and dimensions											
Weight	kg	9,0	9,5	12,4	12,5	12,5	20	20	20	20	25
Height	mm	340	415	358	372	372	503	503	476	476	503
Width	mm	209	253	210	222	222	286	286	286	286	286
Diameter	mm	182	220	183	183	183	220	220	220	220	220

## Typical applications

- General construction
- Mining
- Tunneling

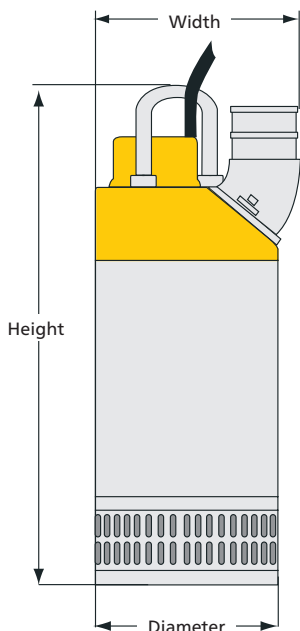



# Performance curves

**WEDA D04N**

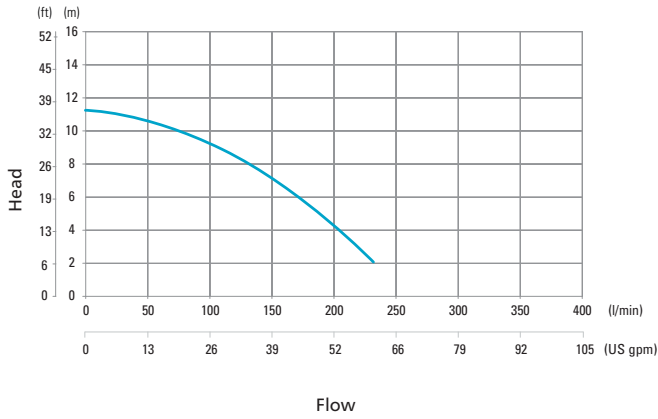

**WEDA D04BN**

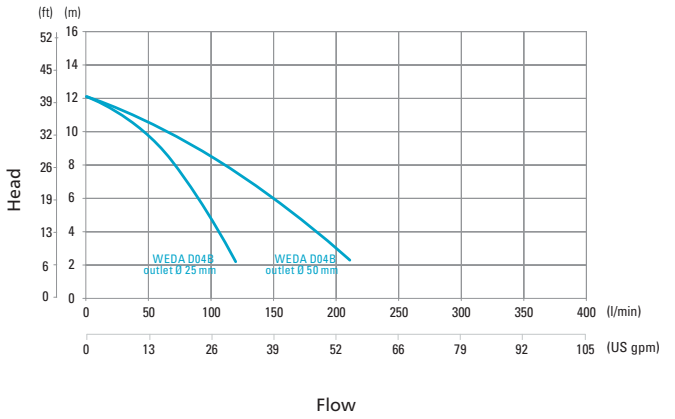

**WEDA D08N**

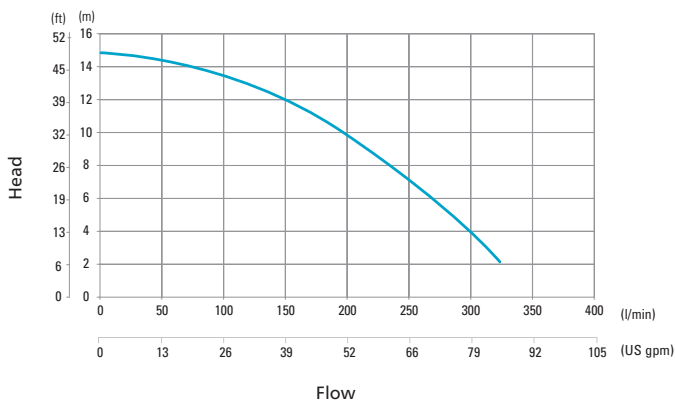

**WEDA D10N**

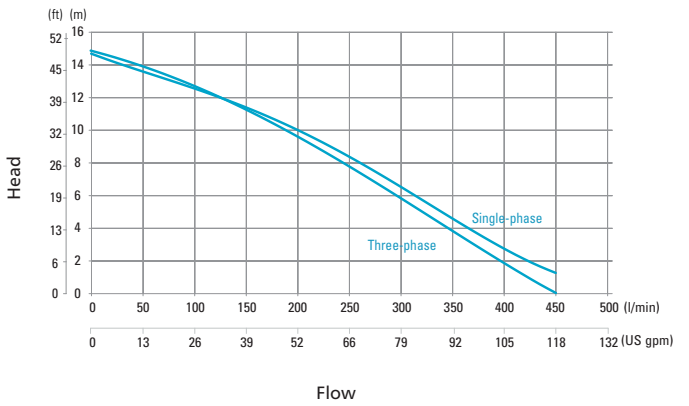

**WEDA D30L, D30N**

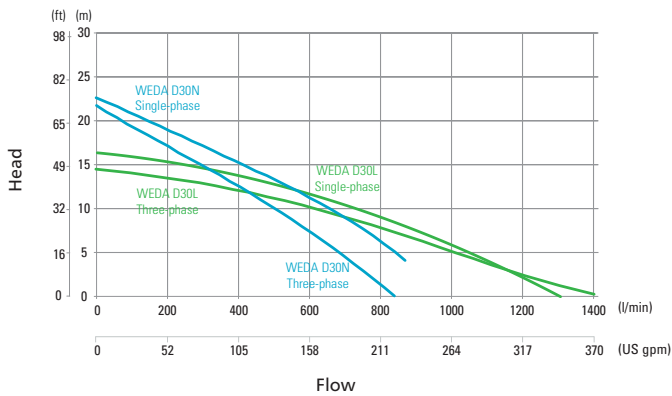

**WEDA D40N**

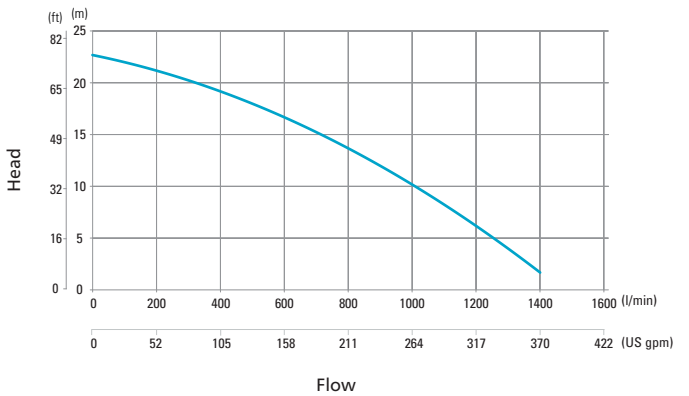

— Normal head  
— Low head

According to ISO 9906 – ANNEX A

# WEDA D range

## Technical data



		WEDA D50N	WEDA D50H	WEDA D60N	WEDA D60H	WEDA D60SH	WEDA D70L	WEDA D70H	WEDA D80N	WEDA D80H	WEDA D90L	WEDA D90H	WEDA D100N
Specifications		3ph	3ph	3ph	3ph	3ph	3ph	3ph	3ph	3ph	3ph	3ph	3ph
Max. head	m	24	39	29	38	60	32	65	40	65	46	96	43
Max. flow	l/min	2300	1200	2600	1500	1050	4750	1583	6000	2500	6777	2111	16.200
	m <sup>3</sup> /h	138	72	156	90	63	285	95	360	150	407	127	972
Rated output	kW	5,6	5,6	7,5	7,5	7,5	11,8	11,8	20	20	26,5	26,5	54
Max. power input	kW	6,6	6,6	8,8	8,8	8,8	14,0	13,8	22	22	29,3	29,3	65
Discharge connection	in	4" (3")	3" (4")	4" (3")	3" (4")	3" (4")	6" (4")	4" (6")	6" (4")	4" (6")	6" (4")	4" (6")	10"
Max solids handling size	mm	8	8	8	8	8	7	7	12	12	7	7	12
Weight and dimensions													
Weight	kg	56	55	61	61	62	95	95	180	180	180	180	510
Height	mm	720	720	760	760	760	911	911	980	980	1058	1058	1412
Width	mm	330	302	330	302	302	395	395	690	665	437	437	650
Diameter	mm	278	278	278	278	278	360	360	530	530	401	401	600

## Typical applications

- General construction
- Mining
- Tunneling

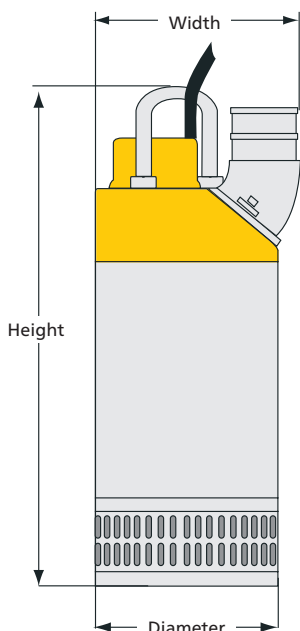

# Performance curves

**WEDA D50N, D50H**

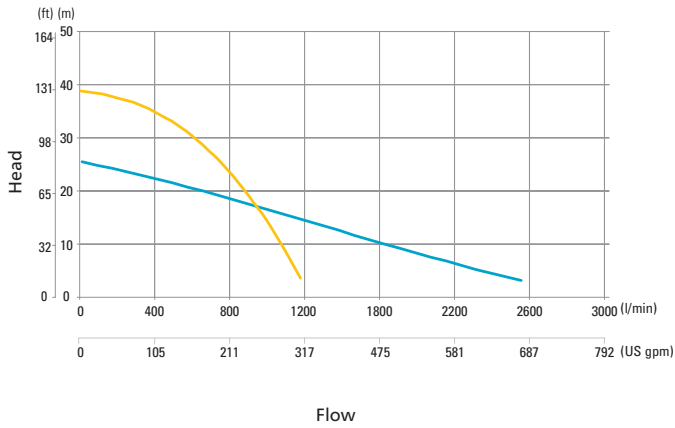

**WEDA D60N, D60H, D60SH**

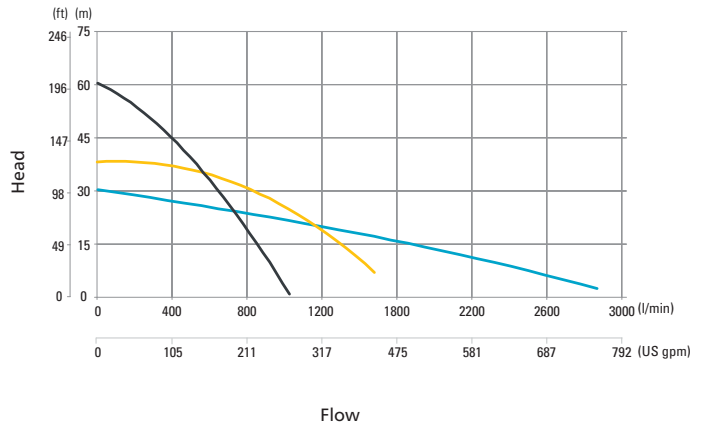

**WEDA D70L, D70H**

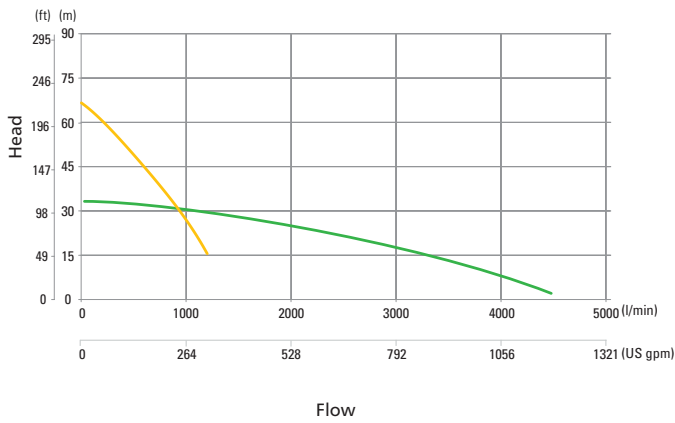

**WEDA D80N, D80H**

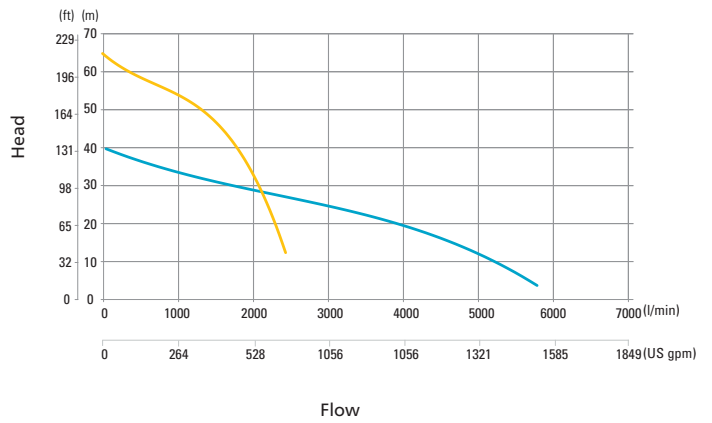

**WEDA D90L, D90H**

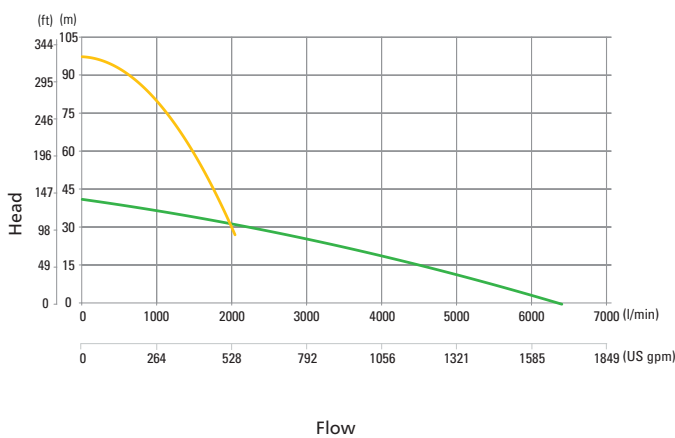

**WEDA D100N**

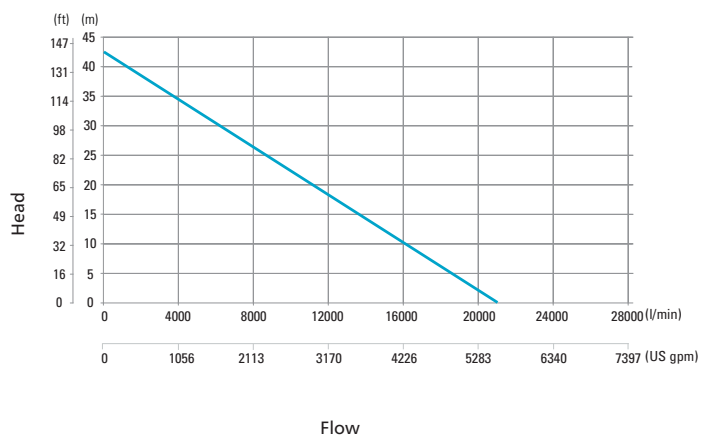

- Super high head
- High head
- Normal head
- Low head

According to ISO 9906 – ANNEX A

# WEDA S range

## Technical data



		WEDA S04N	WEDA S08N	WEDA S30N		WEDA S60N
Specifications		1ph	1ph	1ph	3ph	3ph
Max. head	m	10,5	13,0	12,5	15	25
Max. flow	l/min	270	317	700	900	1750
	m <sup>3</sup> /h	16,2	19,0	45	54	420
Rated output	kW	0,40	0,75	1,8	2,5	6,9
Max. power input	kW	0,65	1,2	2,2	3,3	8,0
Discharge connection	in	2"	2"	3"	3"	4" (3")
Max solids handling size	mm	25	25	50	50	50
Weight and dimensions						
Weight	kg	10	13	25	25	65
Height	mm	375	416	620	620	870
Width	mm	277	277	326	326	450
Diameter	mm	241	241	250	250	350

## Typical applications

- Mining
- Construction sites
- Industries

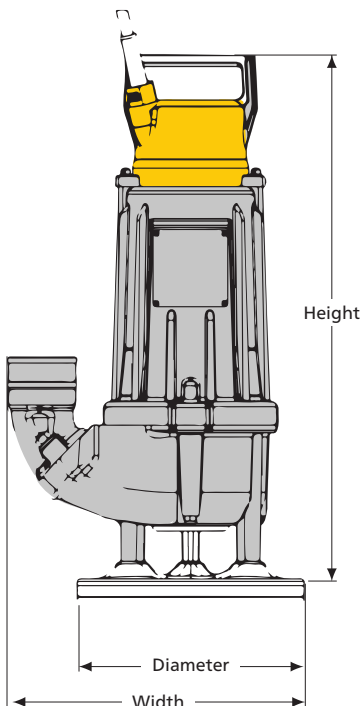

# Performance curves

 **WEDA S04N**

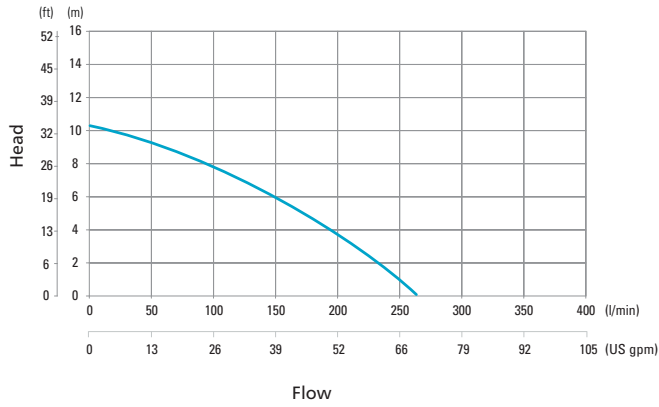

 **WEDA S08N**

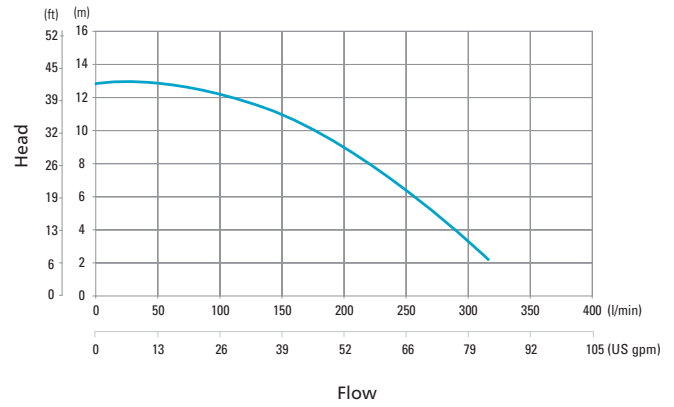

 **WEDA S30N**

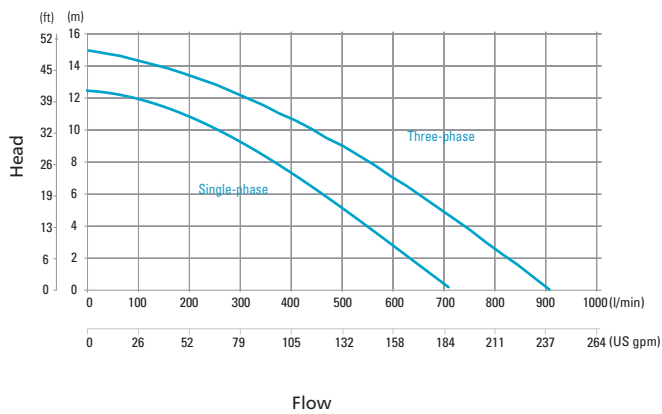

 **WEDA S60N**

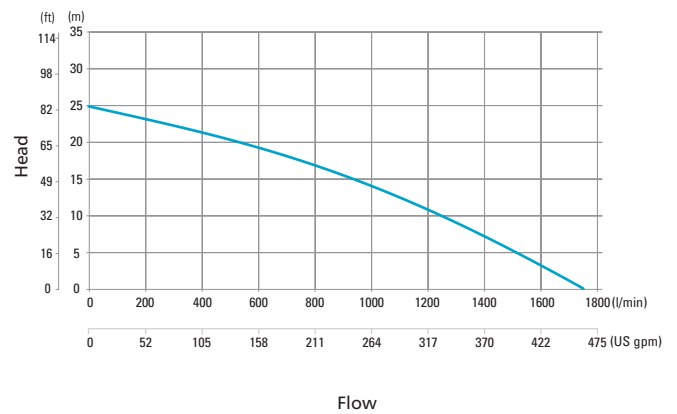

 Normal head

# WEDA L range

## Technical data



		WEDA L40N	WEDA L50N	WEDA L60N	WEDA L70N	WEDA L80N	WEDA L95N	WEDA L100N	WEDA L110N
<b>Specifications</b>		3ph	3ph	3ph	3ph	3ph	3ph	3ph	3ph
Max. head	m	13,4	17,0	22,8	24	27	51	30	50
Max. flow	l/min	1134	1667	2334	2500	2667	4667	7251	9169
	m <sup>3</sup> /h	68	70	140	150	160	280	435	550
Rated output	kW	3,70	5,50	9,0	11,0	15,0	37	45	75
Max. power input	kW	4,5	6,8	10,4	12,8	16,1	40,1	48,8	79,9
Discharge connection	in	3	4	4	4	4	4	6	6
Max solids handling size	mm	20	25	25	25	25	35	60	60
<b>Weight and dimensions</b>									
Weight	kg	185	260	260	270	310	750	1005	1070
Height	mm	793	914	914	914	1080	1605	1605	1605
Width	mm	388	435	435	435	580	935	935	935
Diameter	mm	337	413	413	413	495	546	546	546

## Typical applications

- Quarries
- Mining
- Settling ponds

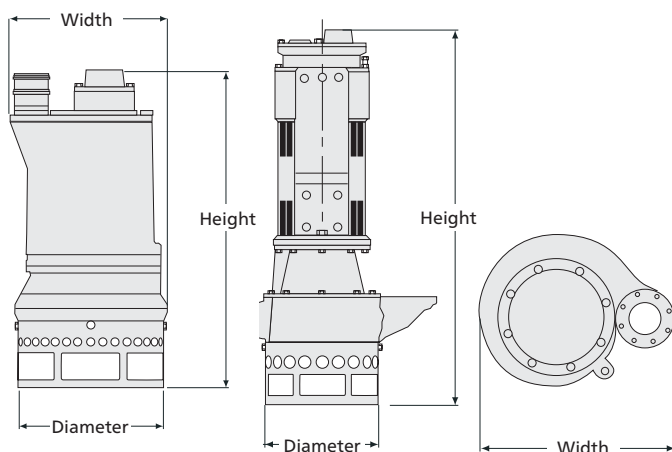

# Performance curves

 **WEDA L40N**

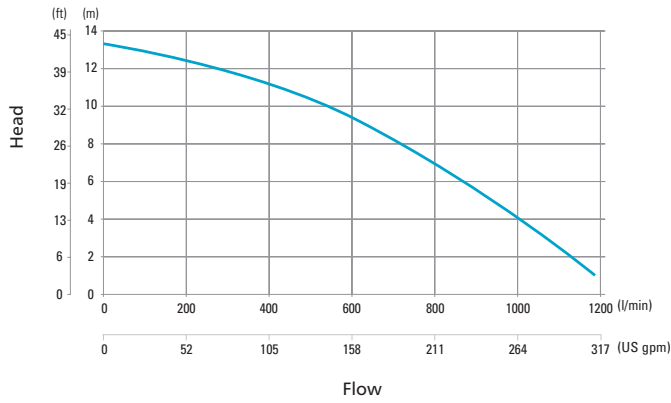

 **WEDA L50N**

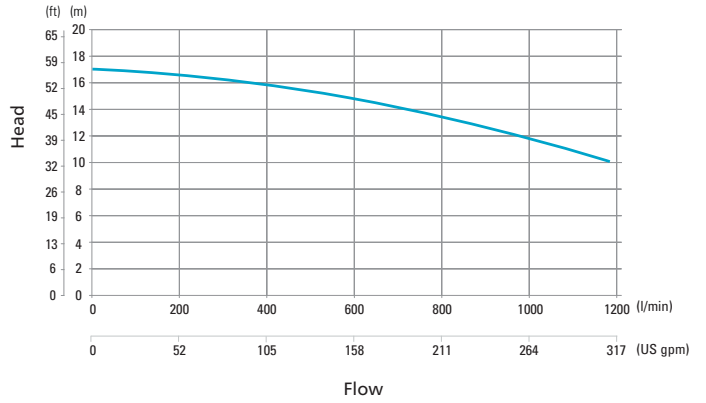

 **WEDA L60N**

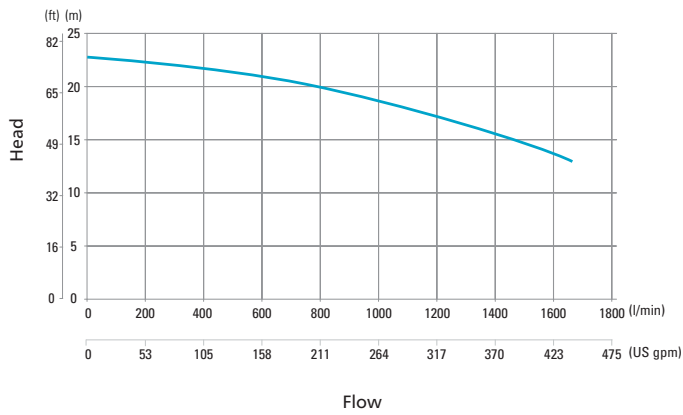

 **WEDA L70N**

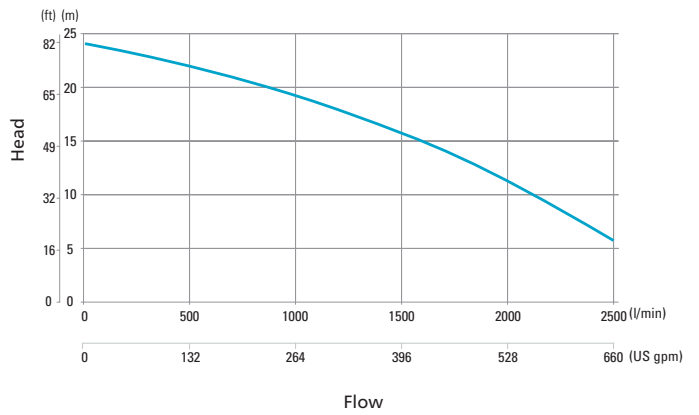

 **WEDA L80N**

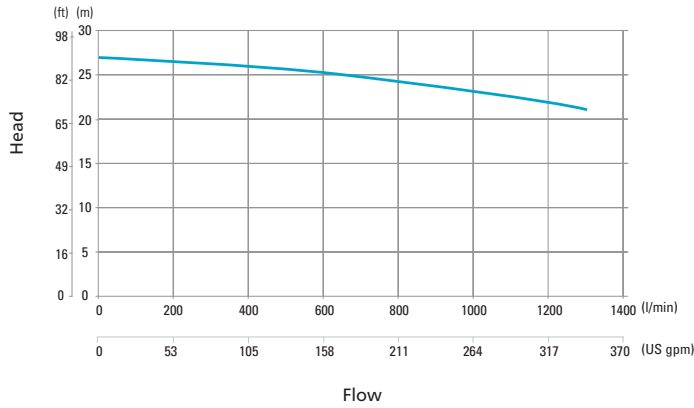

 **WEDA L95N**

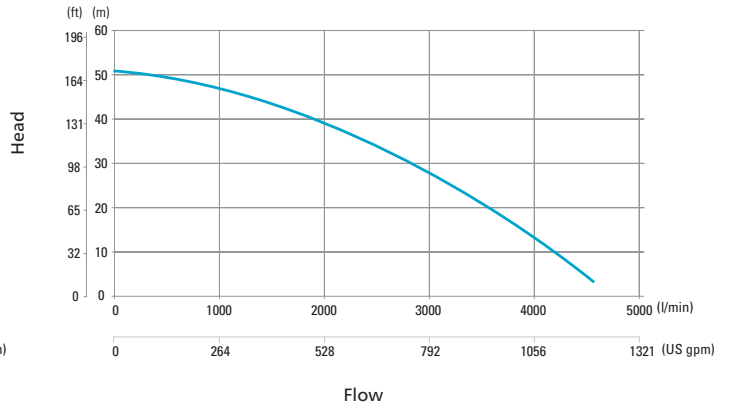

 **WEDA L100N**

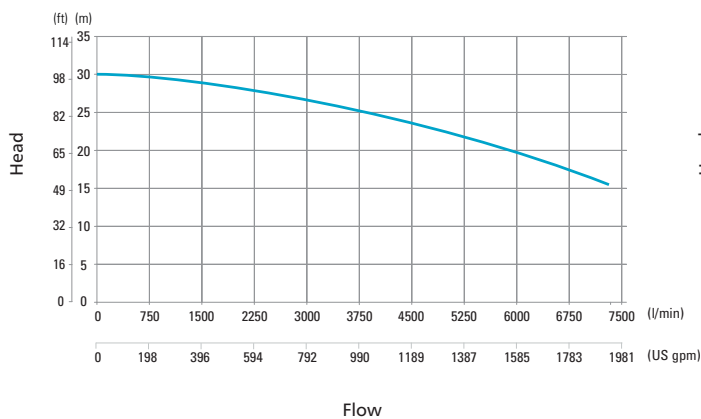

 **WEDA L110N**

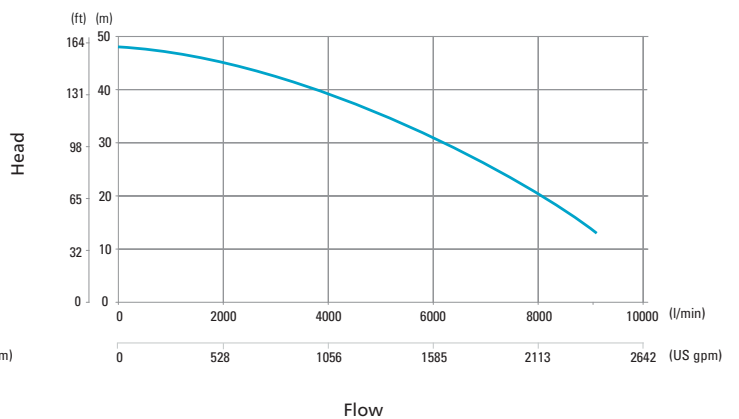

— Normal head

# Accessories

## Discharge connections

We understand that you will have preferred equipment connections, so we offer four types. All can be mounted in either a vertical or horizontal position.

- Hose



- Storz



- ISO-G



- NPT



## Level regulators

For easy control of water level by automatic pump switch-on/-off:

- Float switch



## Zinc anodes

Specifically required for pumping water with a high concentration of salts such as sea water, brine, etc.



## Low suction collar

To easily drain the water level down to the floor.

## Hoses

Multiple hose options with a variety of end connections are available in different lengths ready in stock.

## Epoxy coating

For additional protection against corrosion.

# Service kits

## Seal kit

The seal kit is the proper selection of high quality components for a mechanical seal change to ensure trouble-free operation after servicing.

- O-ring kit
- Mechanical shaft seal



## Instant service pack

The instant service pack is a preassembled, tested and ready-to-use seal system containing the mechanical shaft seals, bearings, gaskets and oil to ensure trouble-free operation. It offers a quick onsite repair option due to ease of installation and therefore reduces the machine downtime cost.



## Wear part kit

The wear part kit is a typical selection of components to bring the pump performance back to factory standard. The ideal solution for a machine overhaul or refurbishment.

- Impeller
- Wear plate
- Wear plate gasket
- Wear plate fixings
- Shaft key
- Impeller nut
- Rear wear plate\*







# DIP pneumatic pump

A pneumatic pump is a great choice when failure is not an option. They're easy to use, safe and can handle almost anything you throw at them.

The DIP centrifugal pumps can be made to suit several operations. With a simple change of impeller and intake ring you can adjust to the desired capacity and head. That means you get a three-in-one solution. The DIP is designed to handle relatively clean low-viscosity liquids such as water and cooling fluids.

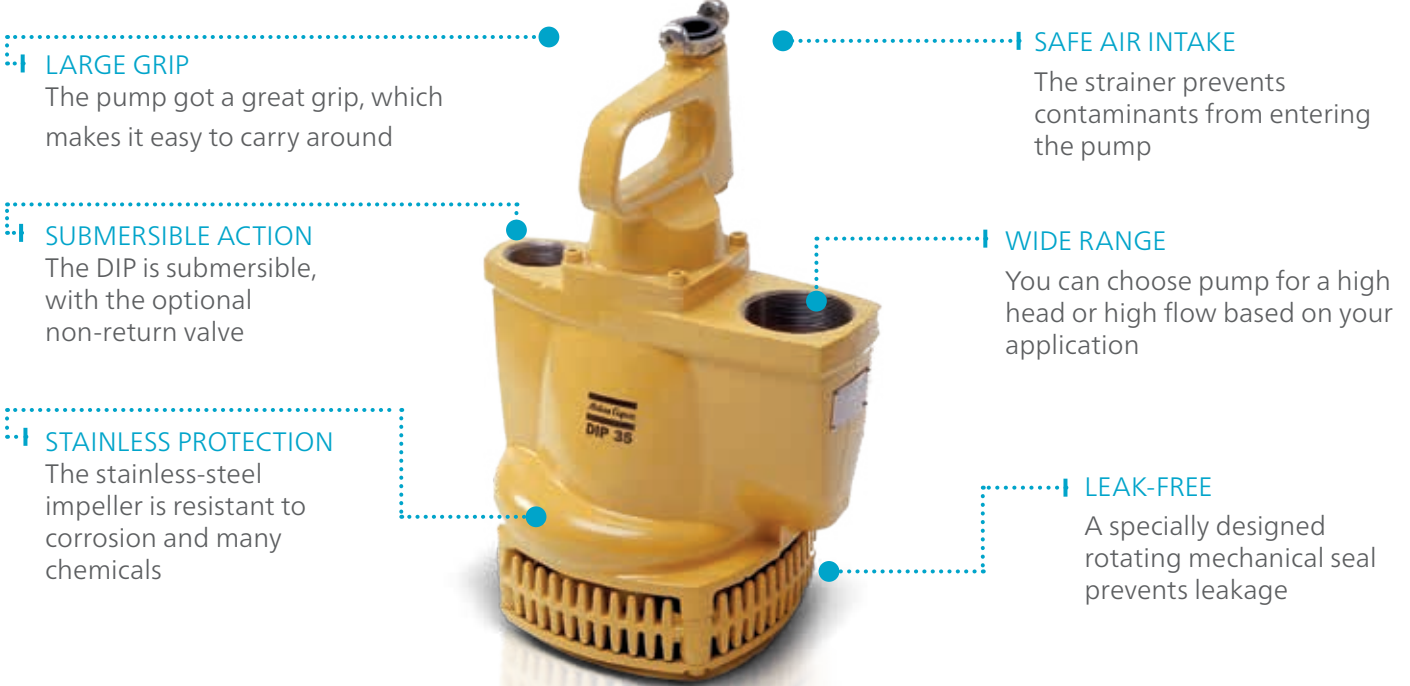

**LARGE GRIP**  
The pump got a great grip, which makes it easy to carry around

**SUBMERSIBLE ACTION**  
The DIP is submersible, with the optional non-return valve

**STAINLESS PROTECTION**  
The stainless-steel impeller is resistant to corrosion and many chemicals

**SAFE AIR INTAKE**  
The strainer prevents contaminants from entering the pump

**WIDE RANGE**  
You can choose pump for a high head or high flow based on your application

**LEAK-FREE**  
A specially designed rotating mechanical seal prevents leakage

## Flow chart

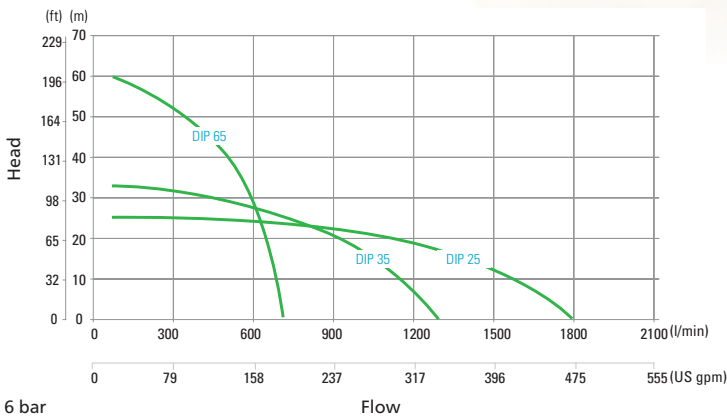

Specifications			DIP 25	DIP 35	DIP 65
Max. head		m	25	35	59
Max. flow		l/min	1680	1320	660
Max. flow		m <sup>3</sup> /h	270   58,1	79,2	39,6
Max. air requirements		l/s	70	70	70
Connection thread <sup>1</sup>	Fluid outlet	in	G 2 1/2	G 2 1/2	G 2 1/2
	Air inlet	in	G 3/4	G 3/4	G 3/4
	Air outlet	in	G 1 1/2	G 1 1/2	G 1 1/2
Weight and dimensions					
Weight		kg	23	23	23
Length		mm	235	235	235
Width		mm	288	288	288
Height		mm	435	435	435

# DOP pneumatic pump

When the going gets tough, the tough get a DOP diaphragm pump. They are designed for the most polluted and viscous media, as well as highly abrasive and flammable fluids.

## EASY TO HANDLE

It only takes one person to handle the DOP

## SAFE INTAKE

The air intake with strainer prevents contaminants from entering the pump via the air

## SELF-PRIMING

Reduces unnecessary handling in rough environments

## REACH THE CORNERS

Thanks to the pivoting intake coupling together with an optional suction hose

## SUBMERSIBLE

The built-in non-return valve makes the pump submersible and independent of orientation; add a silencer for lower noise levels

## LIFT MORE

The DOP can be connected in series to increase the lifting capacity, or "head"

## PIVOTING CONNECTION

Reduces stress on the hose

## STABLE OPERATIONS

The strainer at the base prevents particles larger than 30 mm from passing through the pump



## Flow chart

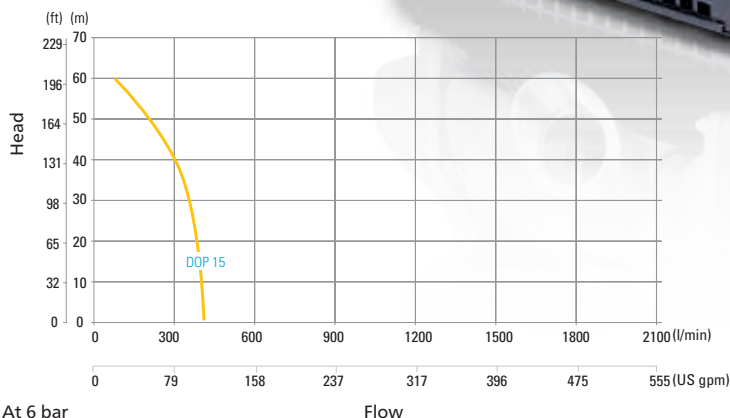

Specifications			DOP 15N	DOP 15F
Max. head		m	59	59
Max. flow		l/min	420	420
Max. flow		m <sup>3</sup> /h	25,2	25,2
Max. air requirements		l/s	34	34
Connection thread <sup>1</sup>	Fluid outlet	in	G 2 1/2	G 2 1/2
	Air inlet	in	G 3/4	G 3/4
Weight and dimensions				
Weight		kg	31	31
Length		mm	390	390
Width		mm	330	330
Height		mm	585	585

# Product portfolio

## GENERATORS

**PORTABLE**  
1,6–12 kVA



**MOBILE**  
9–1250\* kVA



**INDUSTRIAL**  
10–2250\* kVA



**CONTAINERS**  
800–1450 kVA



\*Multiple configurations available to produce power for any size application

## DEWATERING PUMPS

**ELECTRIC SUBMERSIBLE**  
250–23.300 l/min



**SURFACE PUMPS**  
833–23.300 l/min



**SMALL PORTABLE**  
210–2500 l/min



Diesel and electric options available

## LIGHT TOWERS

**DIESEL LED AND MH**



**BATTERY LED**



**ELECTRIC LED**



## AIR COMPRESSORS AND HANDHELD TOOLS

**AIR COMPRESSORS**  
1–116 m<sup>3</sup>/min  
7–345 bar



**HANDHELD TOOLS**  
Pneumatic  
Hydraulic  
Petrol engine driven



## ONLINE SOLUTIONS

**SHOP ONLINE  
PARTS ONLINE**

Find and order the spare parts for power equipment. We handle your orders 24 hours a day.



**POWER CONNECT**

Scan the QR code on your machine, and go to the QR Connect Portal to find all the information about your machine.



**FLEETLINK**

Intelligent telematics system that helps optimize fleet usage, reduce maintenance costs, ultimately saving time and cost.

